



























EXM-2750.3 HARDWARE ILLUSTRATION SHEET

Qty.	Qty.				
[1PCS]	[1PCS]	A1. 1/2"X5 1/4" HEX HEAD BOLT	A1		C5. 5/16" SPRING WASHER
[4PCS]	[4PCS]	A2. 1/2"X4" HEX HEAD BOLT	A2		C6. 3/8" ROUND END CAP WASHER
[1PCS]	[1PCS]	A3. 1/2"X3 3/4" HEX HEAD BOLT	A3		A4
[13PCS]	[13PCS]	A4. 1/2"X3" HEX HEAD BOLT	A4		A5
[1PCS]	[1PCS]	A5. 1/2"X2 3/4" HEX HEAD BOLT	A5		
[2PCS]	[2PCS]	A6. 3/8"X7 1/4" HEX HEAD BOLT	A6		A7
[8PCS]	[8PCS]	A7. 3/8"X2 3/4" HEX HEAD BOLT	A7		A8
[16PCS]	[16PCS]	A8. 3/8"X1 1/2" HEX HEAD BOLT	A8		A9
[2PCS]	[2PCS]	A9. 3/8"X1" HEX HEAD BOLT	A9		A10
[1PCS]	[1PCS]	A10. 3/8"X1/2" HEX HEAD BOLT	A10		A11
[4PCS]	[4PCS]	A12. 5/16X1 3/4" HEX HEAD BOLT	A12		A12
[3PCS]	[3PCS]	A13. 5/16"X3/8" SET SCREW	A13		A13
[3PCS]	[3PCS]	A14. 5/16"X1 1/2" ROUND BOLT	A14		A14
[1PCS]	[1PCS]	A15. 7/16"X1 1/2" ROUND BOLT	A15		A15
[1PCS]	[1PCS]	A16. 5/8" ROUND BOLT	A16		A16
[1PCS]	[1PCS]	A17. 10BL PIN	A17		A17
[1PCS]	[1PCS]	A18. STEEL CHAIN	A18		A18
[3PCS]	[3PCS]	A19. 1/2"X22 SLEEVE	A19		A19
[2PCS]	[2PCS]	A20. 1/2"X3 1/2" HEX HEAD BOLT	A20		A20
[20PCS]	[20PCS]	B1. 1/2" NYLON LOCK NUT	B1		B1
[28PCS]	[28PCS]	B2. 3/8" NYLON LOCK NUT	B2		B2
[3PCS]	[3PCS]	B3. 5/16" NYLON LOCK NUT	B3		B3
[1PCS]	[1PCS]	B4. 5/8" LOCK NUT	B4		B4
[7PCS]	[7PCS]	C1. 1/2" (I.D.) WASHER	C1		C1
[7PCS]	[7PCS]	C2. 3/8" (I.D.) WASHER	C2		C2
[4PCS]	[4PCS]	C3. 5/16" (I.D.) WASHER	C3		C3
[1PCS]	[1PCS]	C4. 5/8" SPRING WASHER	C4		C4

EXM-2750.3 PARTS ILLUSTRATION SHEET

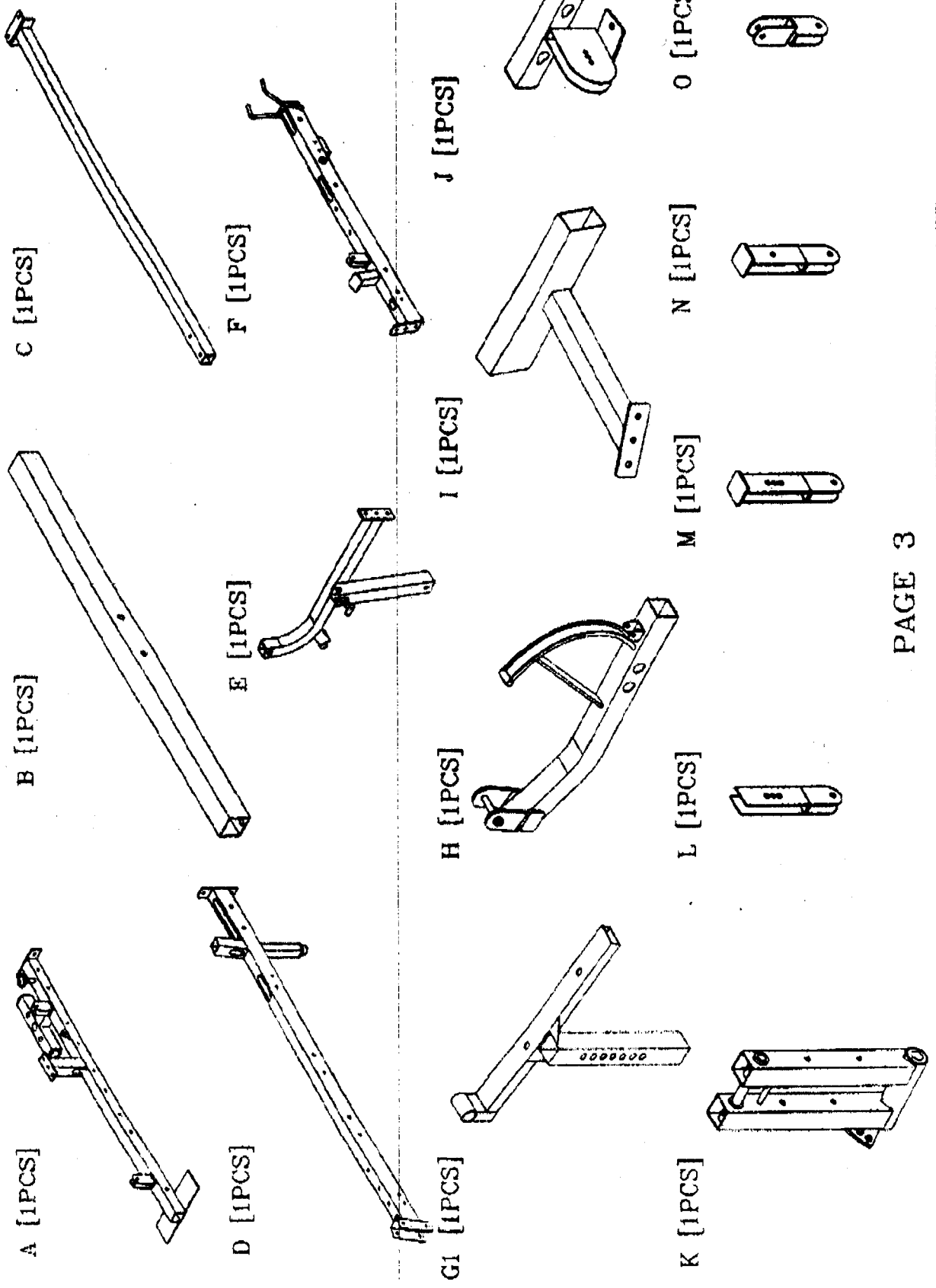

EXM - 2750.3 PARTS ILLUSTRATION SHEET

P [1PCS]

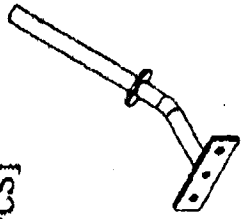

Q [1PCS]

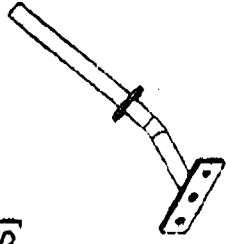

R [1PCS]



S [1PCS]



T [1PCS]



U [2PCS]



V [1PCS]

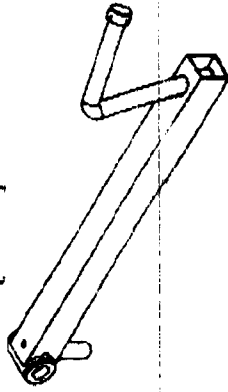

W [1PCS]

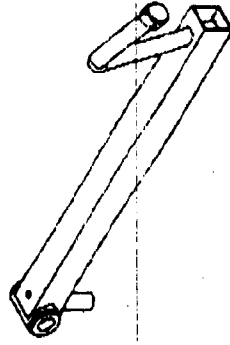

X [2PCS]



Y [2PCS]



AA [1PCS]

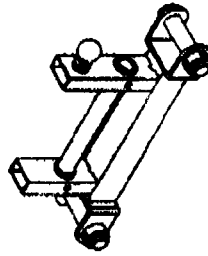

AB-1 [1PCS]

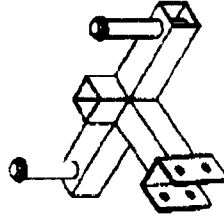

AC [1PCS]



AD [1PCS]

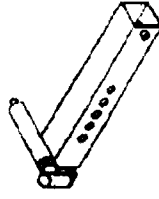

AE [1PCS]

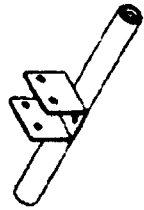

AF-1 [1PCS]

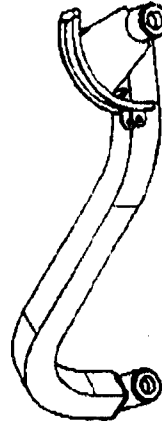

AG-1 [1PCS]

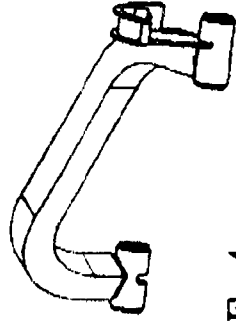

AH [1PCS]

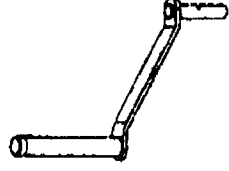

AI [1PCS]

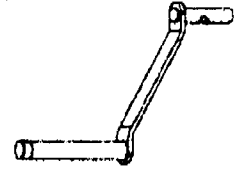

EXM-2750.3 PARTS ILLUSTRATION SHEET

AJ [1PCS]



AK [1PCS]

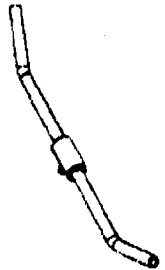

AL [1PCS]

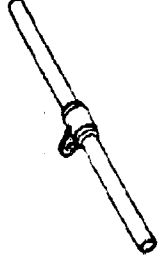

AM [2PCS]
ø1"X475L

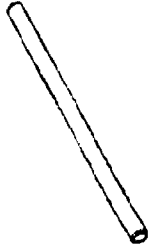

AN [2PCS]
50X6tX150L



AO [1PCS]
50X6tX170L



AP [1PCS]
75X6tX150L

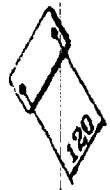

AQ [2PCS]



AS [2PCS]



AT [1PCS]

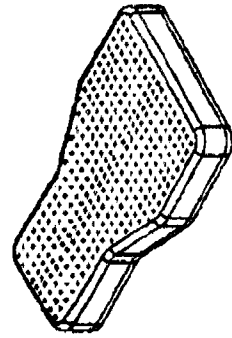

AU [1PCS]

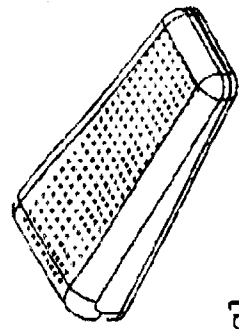

AX [1PCS]

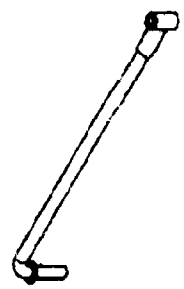

AY [1PCS]

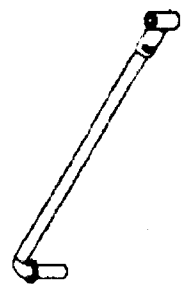

AV-1 [2PCS]

