

THERE IS A RISK ASSUMED BY INDIVIDUALS WHO USE THIS TYPE OF EQUIPMENT. TO MINIMIZE RISK, YOU MUST FOLLOW THESE RULES:

1. Inspect equipment before each workout. Check that all nuts, bolts, screws and pop pins are in place and fully tightened. Also before use, check cables for signs of wear. Replace all worn parts immediately. Never use machine if any parts are damaged or missing. Failure to follow these rules may result in serious injury.
2. Keep clear of the cables and all moving parts when the machine is in use.
3. Always make sure all Snap Links are closed when doing any cable/pulley exercises.
4. Exercise with care. Perform your exercises at a smooth, moderate pace; never perform jerky or uncoordinated movements that may cause injury.
5. It is recommended that you should workout with a training partner.
6. Do not allow children or minors to play on or around this equipment.
7. If unsure of proper use of equipment, call your local Body-Solid distributor or the Body-Solid customer service department at 1-800-556-3113.
8. **WARNING:** Consult your physician before starting your exercise program. For your own safety, do not begin any exercise program without proper instruction.

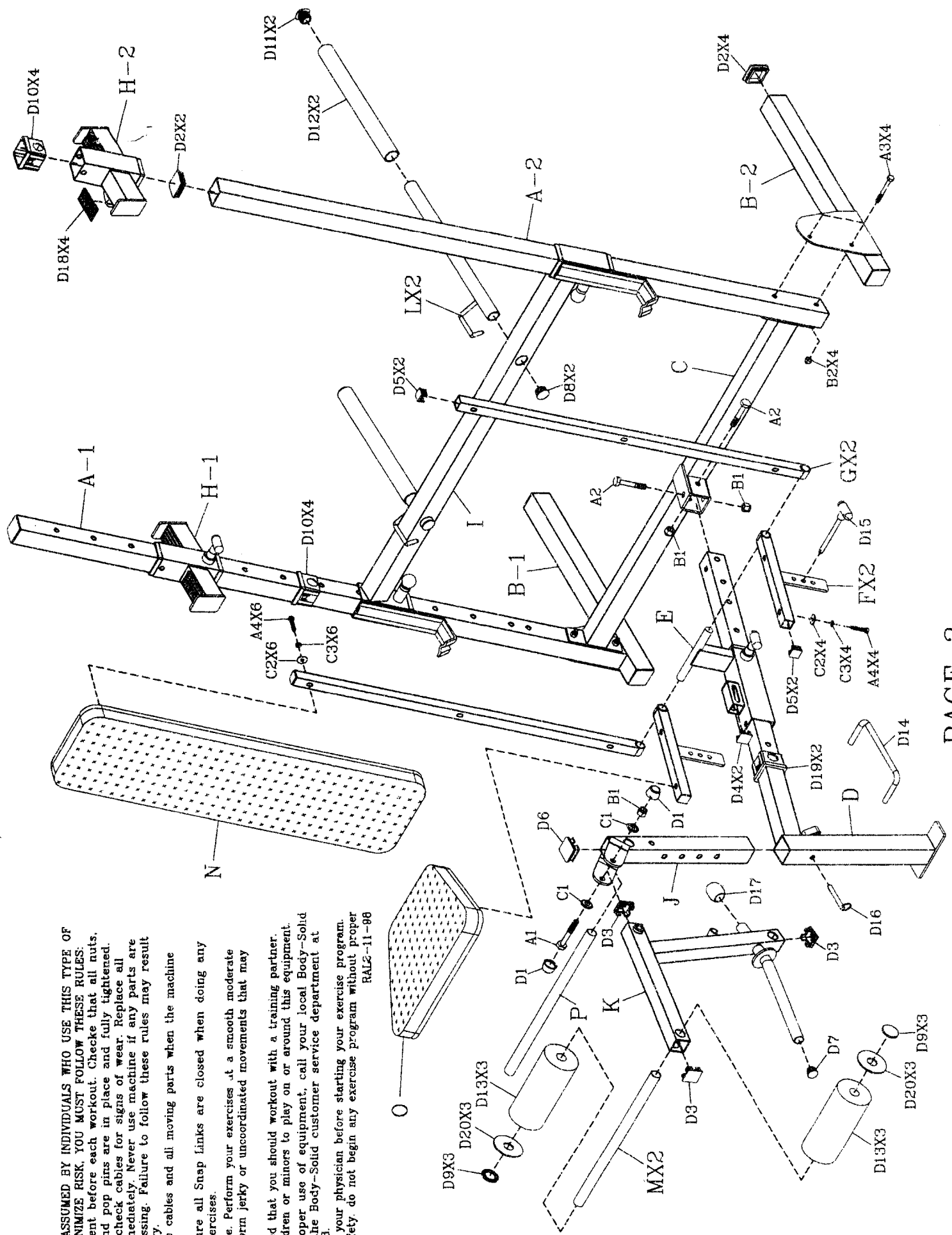

Part No.	Description	Qty.	Part No.	Description	Qty.				
A1	1/2"X3 1/4" HEX HEAD BOLT	[1PCS]	D1	ø1/2" BOLT CAP	[2PCS]				
A2	1/2"X2 3/4" HEX HEAD BOLT	[2PCS]	D2	2"X2" END CAP (E4001)	[6PCS]				
A3	3/8"X3" HEX HEAD BOLT	[4PCS]	D3	38X38 END CAP (E4003)	[3PCS]				
A4	5/16"X1 1/2" HEX HEAD BOLT	[10PCS]	D4	30X30 END CAP (E4026)	[2PCS]				
B1	1/2" NYLON LOCK NUT	[3PCS]	D5	1"X1" END CAP (E4025)	[4PCS]				
B2	3/8" NYLON LOCK NUT	[4PCS]	D6	45X45 END CAP (E4002)	[1PCS]				
C1	1/2" ROUND END WASHER	[2PCS]	D7	ø1" ROUND END CAP (E4012)	[1PCS]				
C2	5/16" (I.D)WASHER	[10PCS]	D8	ø1 1/4" ROUND END CAP (E4078)	[2PCS]				
C3	5/16" SPRING WASHER	[10PCS]	D9	ø1" ROUND END CAP (E10128)	[6PCS]				
A1	A2	A3	A4	D10	60X50 NYLON BUSHING (E4007)	[8PCS]			
B1	B2	C1	C2	C3	D11	ø1 1/4" ROUND END CAP (E4041)	[2PCS]		
					D12	ø32X400 RUBBER GRIP (F4018)	[2PCS]		
					D13	ø3 1/2"X8" FOAM ROLLER (F4004)	[6PCS]		
					D14	SAFETY HOOK (E10024)	[1PCS]		
					D15	ø10X120 BALL PIN (E10003)	[1PCS]		
					D16	ø10X75 RING PIN (E10007)	[1PCS]		
					D17	ø1" RUBBER CANE CAP (E4054)	[1PCS]		
					D18	38X75 RUBBER PAD (E2005)	[4PCS]		
					D19	60X45 NYLON BUSHING (E4008)	[2PCS]		
					D20	ø3" NYLON WASHER (E4085)	[6PCS]		
					D12	D13	D14	D15	
					D16	D17	D18	D19	D20

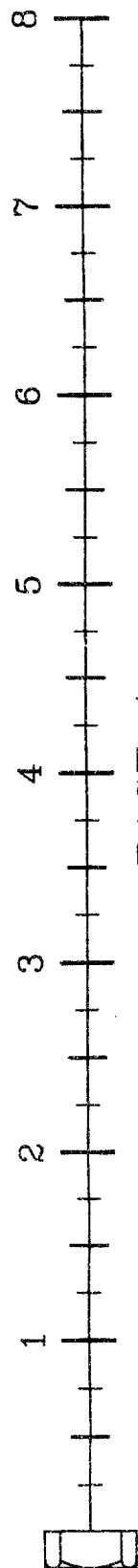

A-1 [1PCS]



A-2 [1PCS]

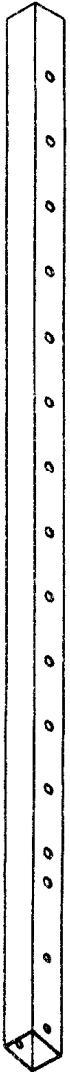

B-1 [1PCS]



B-2 [1PCS]

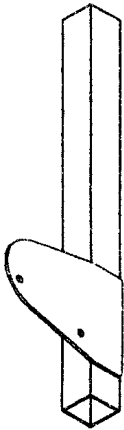

C [1PCS]

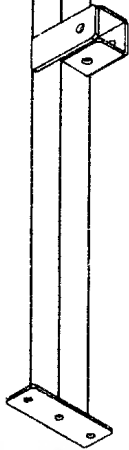

D [1PCS]

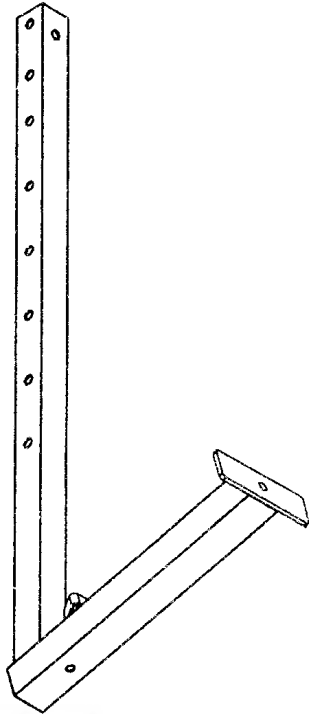

E [1PCS]

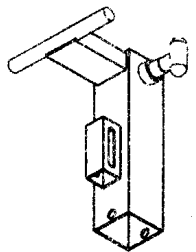

F [2PCS]

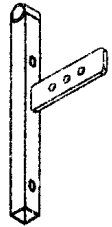

G [2PCS]



H-1 [1PCS]

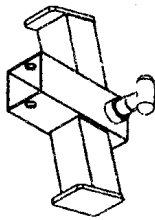

H-2 [1PCS]

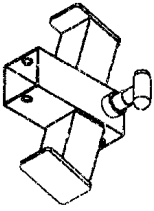

I [1PCS]

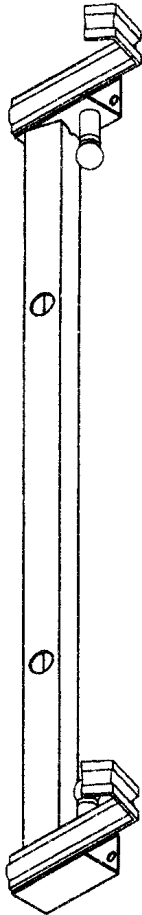

J [1PCS]

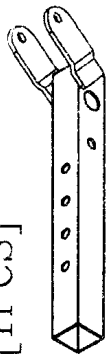

K [1PCS]

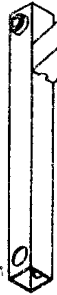

L [2PCS]

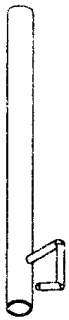

M [2PCS] $\phi 1'' \times 1.6 \times 465L$

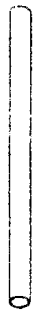

N [1PCS]

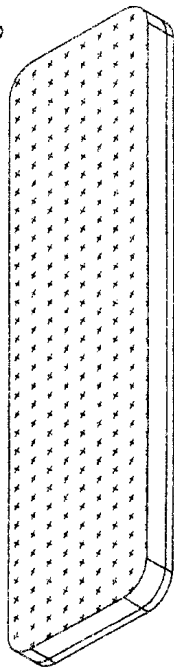

P [1PCS] $\phi 1'' \times 1.6 \times 475L$



O [1PCS]

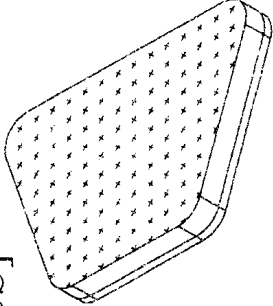

WDIB-69A

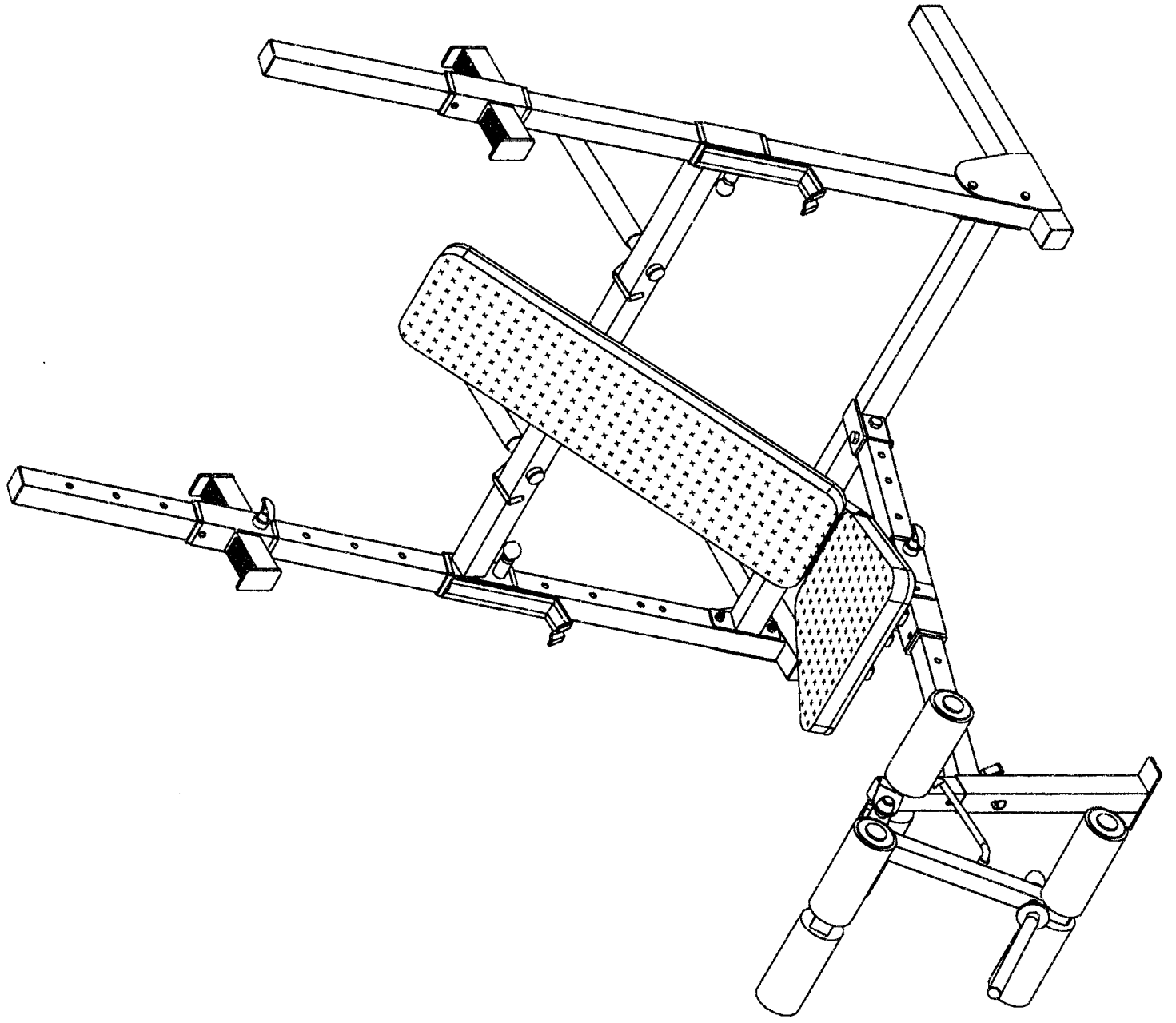

Baby-Solid