

SMH-1500G.1

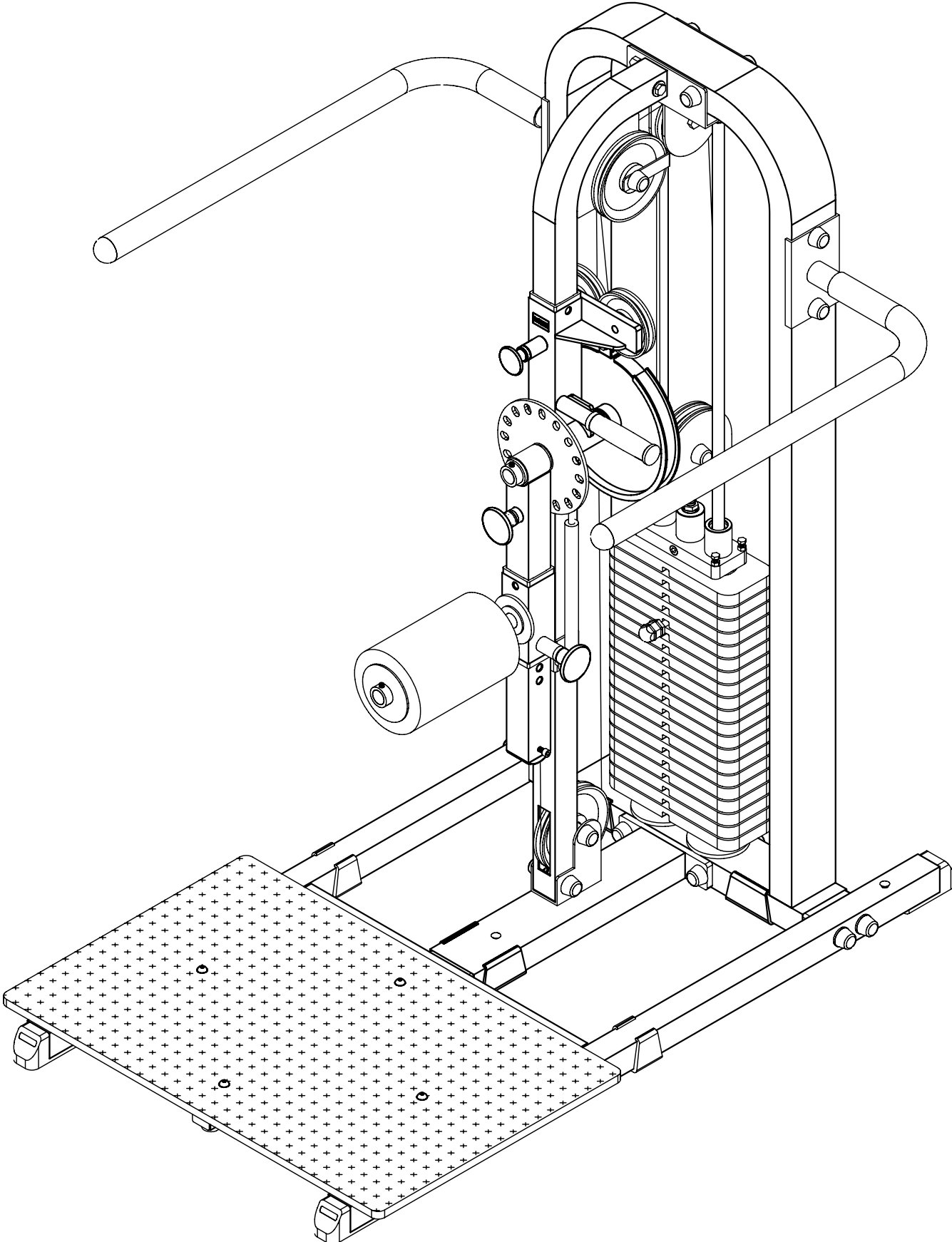

VERSION 0512

SMH-1500G.1 HARDWARE ILLUSTRATION SHEET

	Qty.		
A1. 1/2"X5 1/4" HEX HEAD BOLT -----	[2PCS]	C6. 5/8" SPRING WASHER -----	[1PCS]
A2. 1/2"X5" HEX HEAD BOLT -----	[2PCS]	C7. 1/2" ROUND END CAP WASHER -----	[30PCS]
A3. 1/2"X3" HEX HEAD BOLT -----	[5PCS]	C8. 3/8" ROUND END CAP WASHER -----	[3PCS]
A4. 1/2"X2 1/2" HEX HEAD BOLT -----	[6PCS]	C9. ø4" CHROME WASHER -----	[2PCS]
A5. 1/2"X2 3/4" HEX HEAD BOLT -----	[1PCS]	C10. M10 (I.D) WASHER -----	[2PCS]
A6. 1/2"X2" HEX HEAD BOLT -----	[1PCS]	C11. 5/16" (I.D)WASHERø16 -----	[2PCS]
A7. 1/2"X1 3/4" HEX HEAD BOLT -----	[2PCS]		
A8. 3/8"X2 3/4" HEX HEAD BOLT -----	[1PCS]		
A9. 3/8"X2 1/2" HEX HEAD BOLT -----	[2PCS]		
A10. 3/8"X1 1/4" HEX HEAD BOLT -----	[2PCS]		
A11. M8X60 BUTTON HEAD SCREW -----	[4PCS]		
A13. M10X16L HEX HEAD BOLT -----	[2PCS]		
A14. 7/16"X1 1/2" ROUND HEAD BOLT -----	[1PCS]		
A16. 10LB PIN -----	[1PCS]		
A17. 1/2"X3 1/4" HEX HEAD BOLT-----	[1PCS]		
A18. 5/16"X1 3/4" HEX HEAD BOLT-----	[1PCS]		
A19. 1/2"X22L SLEEVE -----	[1PCS]		
B1. 1/2" NYLON LOCK NUT -----	[13PCS]		
B2. 3/8" NYLON LOCK NUT -----	[3PCS]		
B3. 5/8" LOCK NUT -----	[1PCS]		
B5. M8 NYLON LOCK NUT -----	[4PCS]		
B6. 5/16 NYLON LOCK NUT -----	[1PCS]		
C1. 1/2" (I.D)WASHER -----	[11PCS]		
C2. 3/8" (I.D)WASHER -----	[2PCS]		
C3. M8(I.D)WASHER -----	[8PCS]		
C5. 1/2" SPRING WASHER -----	[2PCS]		

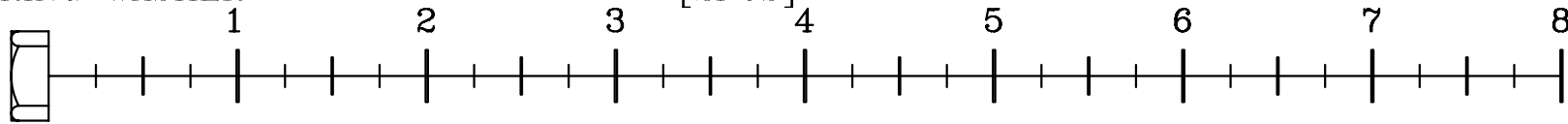
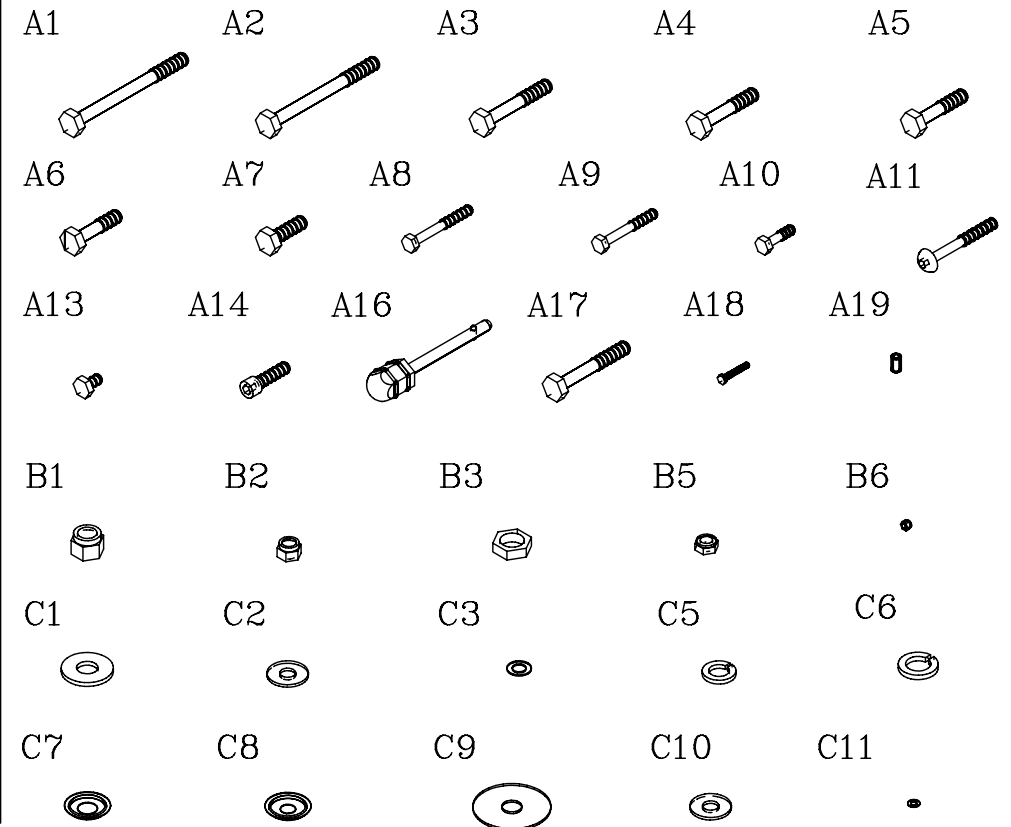

SMH-1500G.1 HARDWARE ILLUSTRATION SHEET

	Qty.
D1. BOLT CAP -----	[33PCS]
D2. $\phi 6$ "X25t PULLEY (9213-009)-----	[2PCS]
D3. $\phi 6$ "X50t PULLEY (9213-009)-----	[1PCS]
D4. $\phi 4$ 1/2" PULLEY (9213-010)-----	[1PCS]
D5. 2"X4" FOOT CAP (9211-025)-----	[4PCS]
D6. 50"X50"X1.8t END CAP (9211-087)-----	[1PCS]
D8. 1 1/2"X1 1/2" END CAP (9211-003)-----	[4PCS]
D9. 60X50 NYLON BUSHING (9211-033)-----	[4PCS]
D11. $\phi 1$ "X34X135 RUBBER GRIP (9212-016)----	[1PCS]
D12. 2"X2" RUBBER DOUNT (9212-010)-----	[2PCS]
D13. 2"X4" RUBBER DOUNT (9212-009)-----	[3PCS]
D14. $\phi 1$ " SHAFT COLLAR (8130-024)-----	[4PCS]
D15. $\phi 3/4$ "X8L STEEL BUSHING (8110-014)----	[3PCS]
D16. $\phi 1$ "X10"L SHAFT BAR (8220-025)-----	[1PCS]
D17. $\phi 4$ " RUBBER DOUNT (9310-017)-----	[2PCS]
D18. $\phi 3$ " NYLON WASHER (9214-008)-----	[2PCS]
D19. TOP PLATE (8400-002)-----	[1PCS]
D20. WEIGHT SELECTOR BAR (8220-060)-----	[1PCS]
D21. $\phi 6$ "X9" FOAM ROLLER (9161-020)-----	[1PCS]
D22. STEEL CABLE -----	[1PCS]
D23. $\phi 3/4$ "X19.5L STEEL BUSHING (8110-017)--	[1PCS]
D24. $\phi 100$ PULLEY (9213-017)-----	[2PCS]
D25. $\phi 5/8$ " ROUND END CAP (9211-015)-----	[3PCS]
D26. $\phi 3/4$ " SHAFT COLLAR (9211-046)-----	[2PCS]

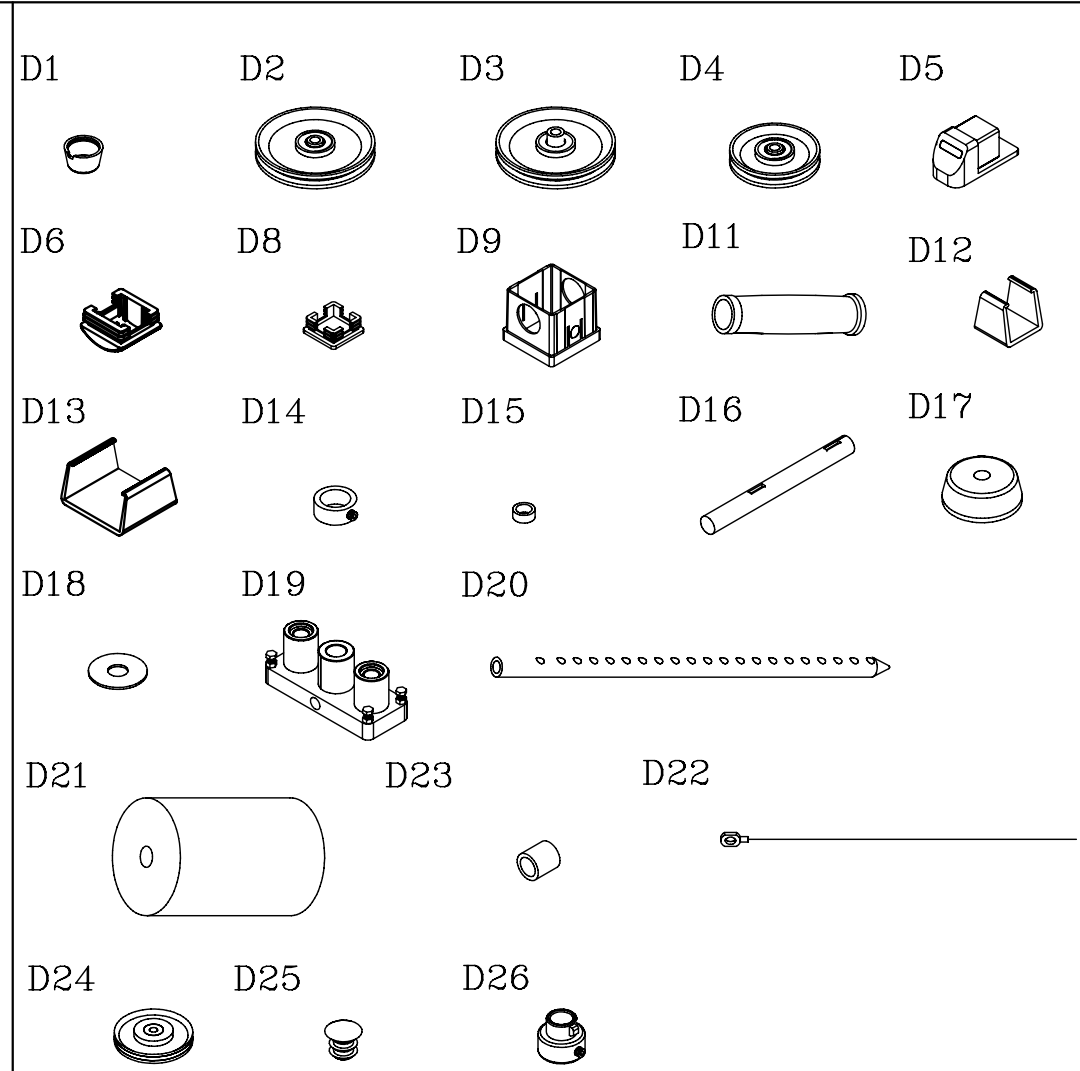

SMH-1500G.1 PARTS ILLUSTRATION SHEET

A [1PCS]

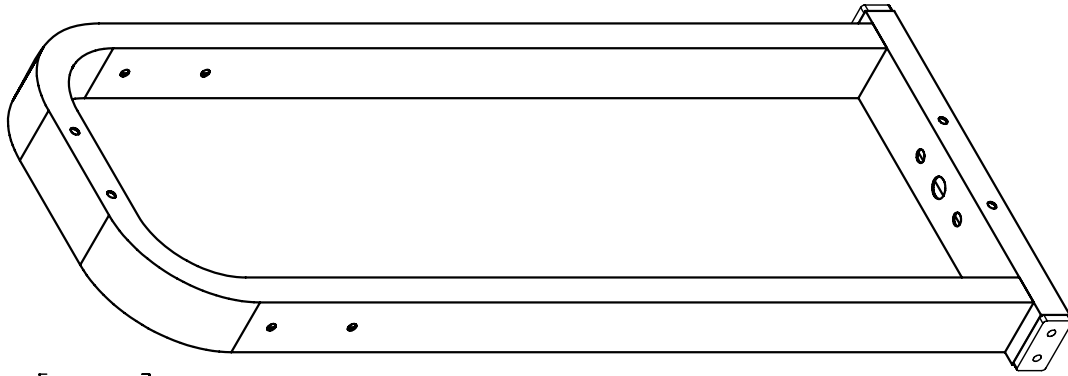

H [1PCS]

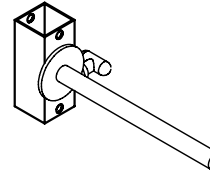

I [1PCS]

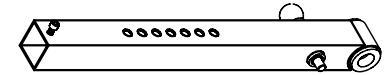

B [1PCS]

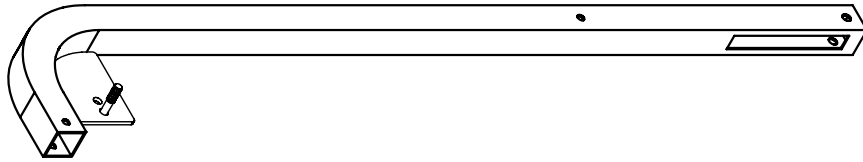

J1 [1PCS]

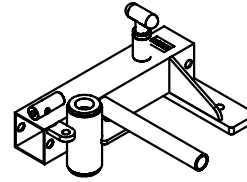

L1 [1PCS]

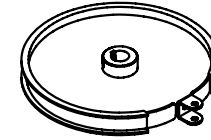

M [1PCS]

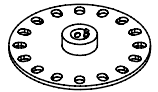

C [1PCS]

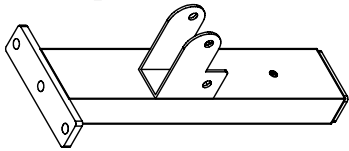

F [1PCS]

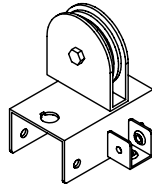

K [2PCS]

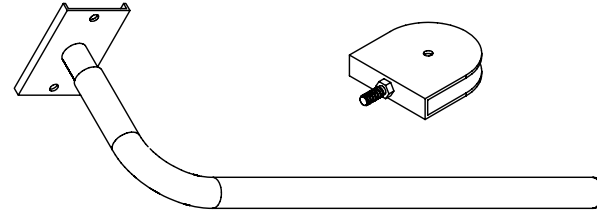

N [1PCS]

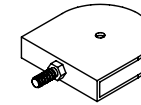

O [1PCS]



Q [2PCS]

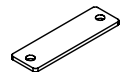

D [1PCS]

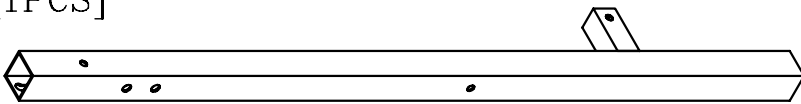

P [1PCS]

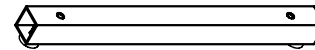

R [1PCS]

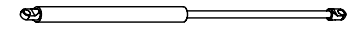

E [1PCS]

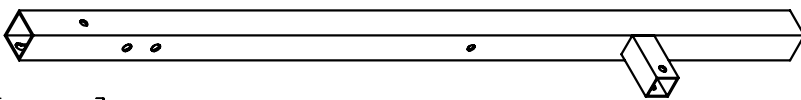

S [2PCS]

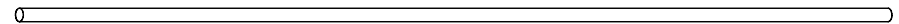

G [1PCS]

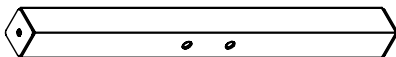

T [1PCS]

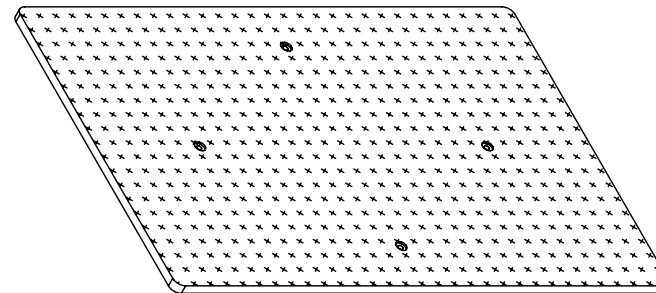

U [1PCS]

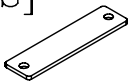

V [2PCS]



W [1PCS]



SMH-1500G.1

THERE IS A RISK ASSUMED BY INDIVIDUALS WHO USE THIS TYPE OF EQUIPMENT. TO MINIMIZE RISK, YOU MUST FOLLOW THESE RULES:

1. Inspect equipment before each workout. Check that all nuts, bolts, screws and pop pins are in place and fully tightened. Also, before use, check cables for signs of wear. Replace all worn parts immediately. Never use machine if any parts are damaged or missing. Failure to follow these rules may result in serious injury.
2. Keep clear of the cables and all moving parts when the machine is in use.
3. Always make sure all Snap Links are closed when doing any cable/pulley exercises.
4. Exercise with care. Perform your exercises at a smooth moderate pace; never perform jerky or uncoordinated movements that may cause injury.
5. It is recommended that you should workout with a training partner.
6. Do not allow children or minors to play on or around this equipment.
7. If unsure of proper use of equipment, call your local Body-Solid distributor or the Body-Solid customer service department at 1-800-556-3113.
8. **WARNING:** Consult your physician before starting your exercise program. For your own safety, do not begin any exercise program without proper instruction.

RAL2-11-98

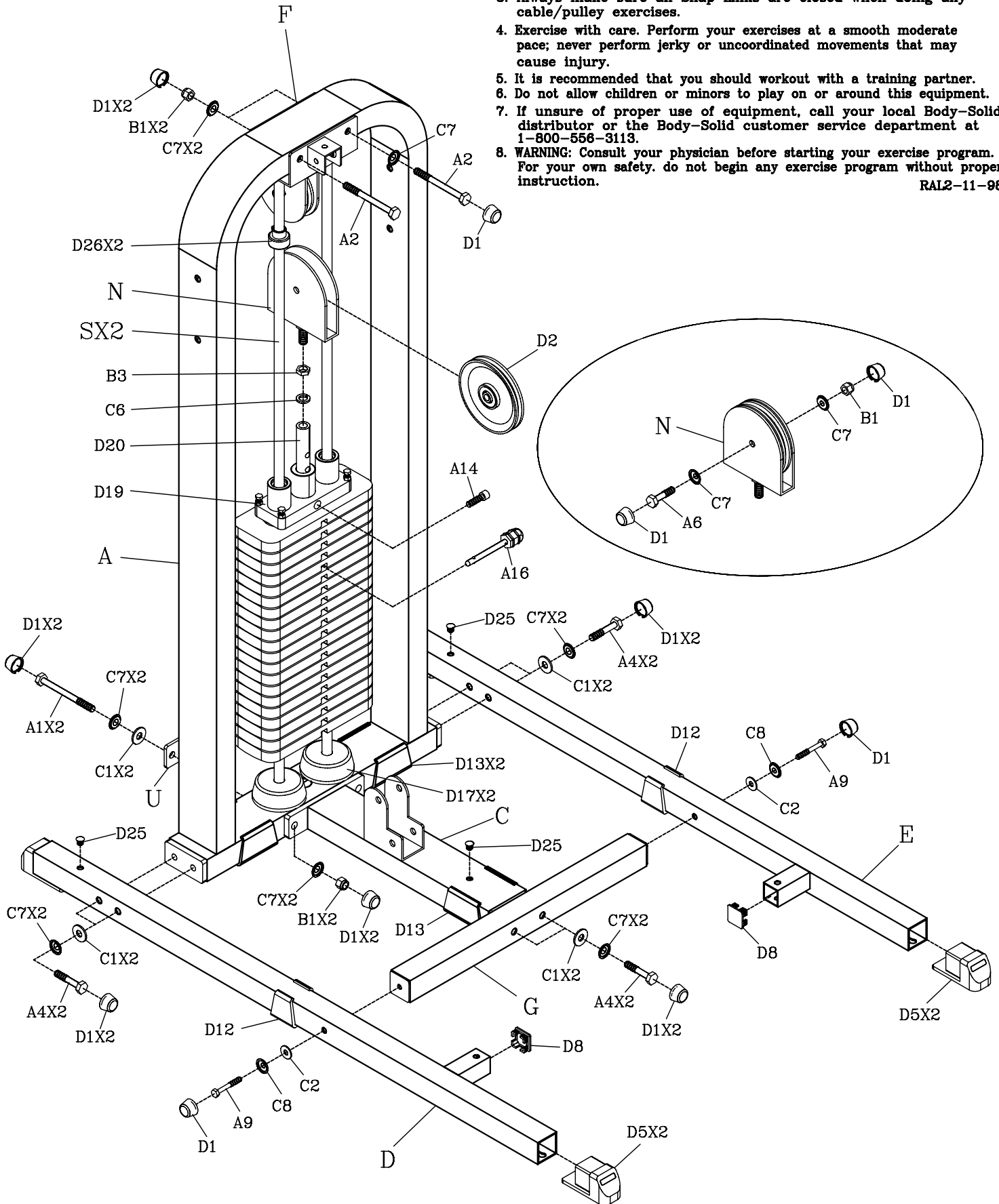

SMH-1500G.1

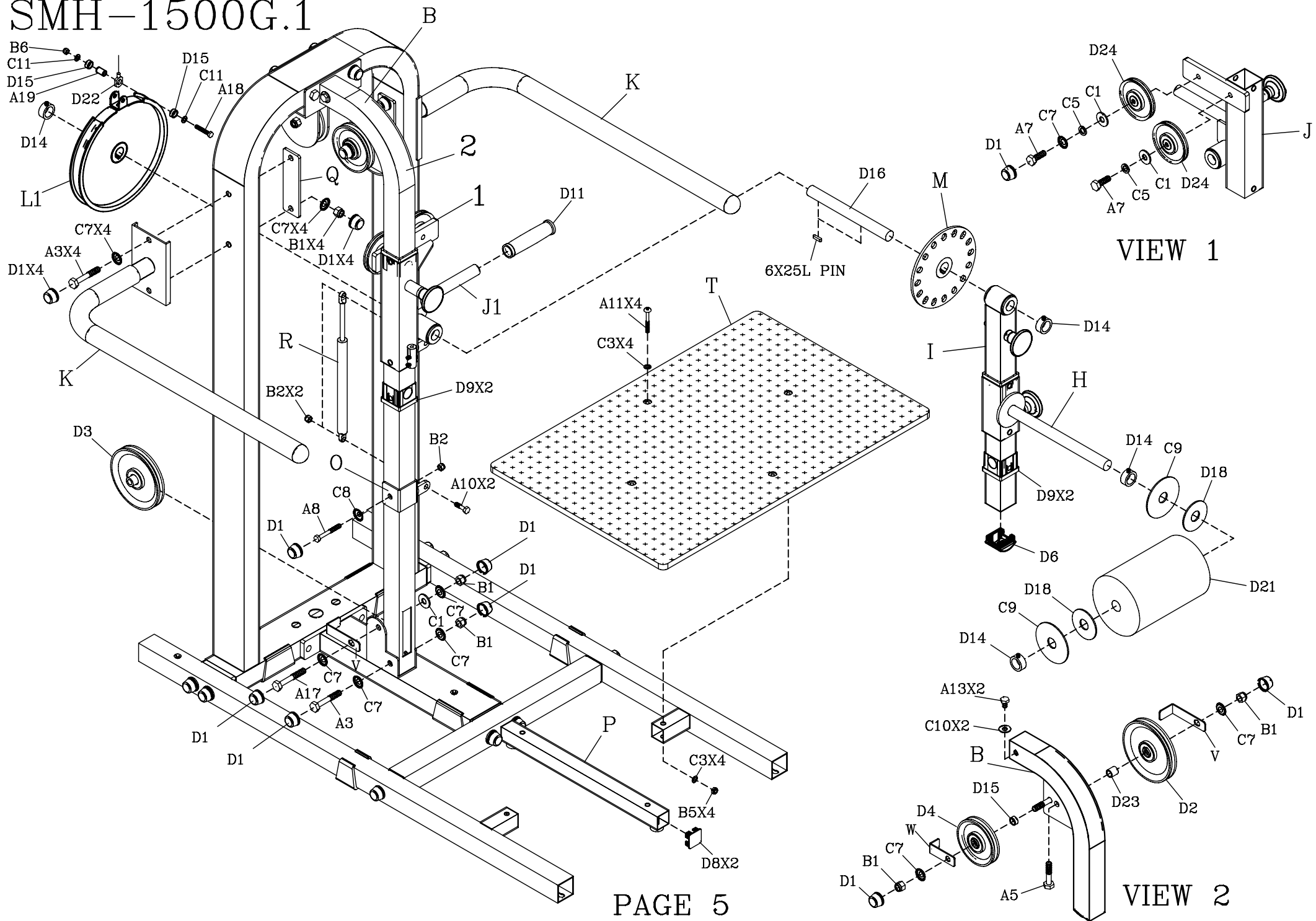

VIEW 1

VIEW 2

SMH-1500G.1

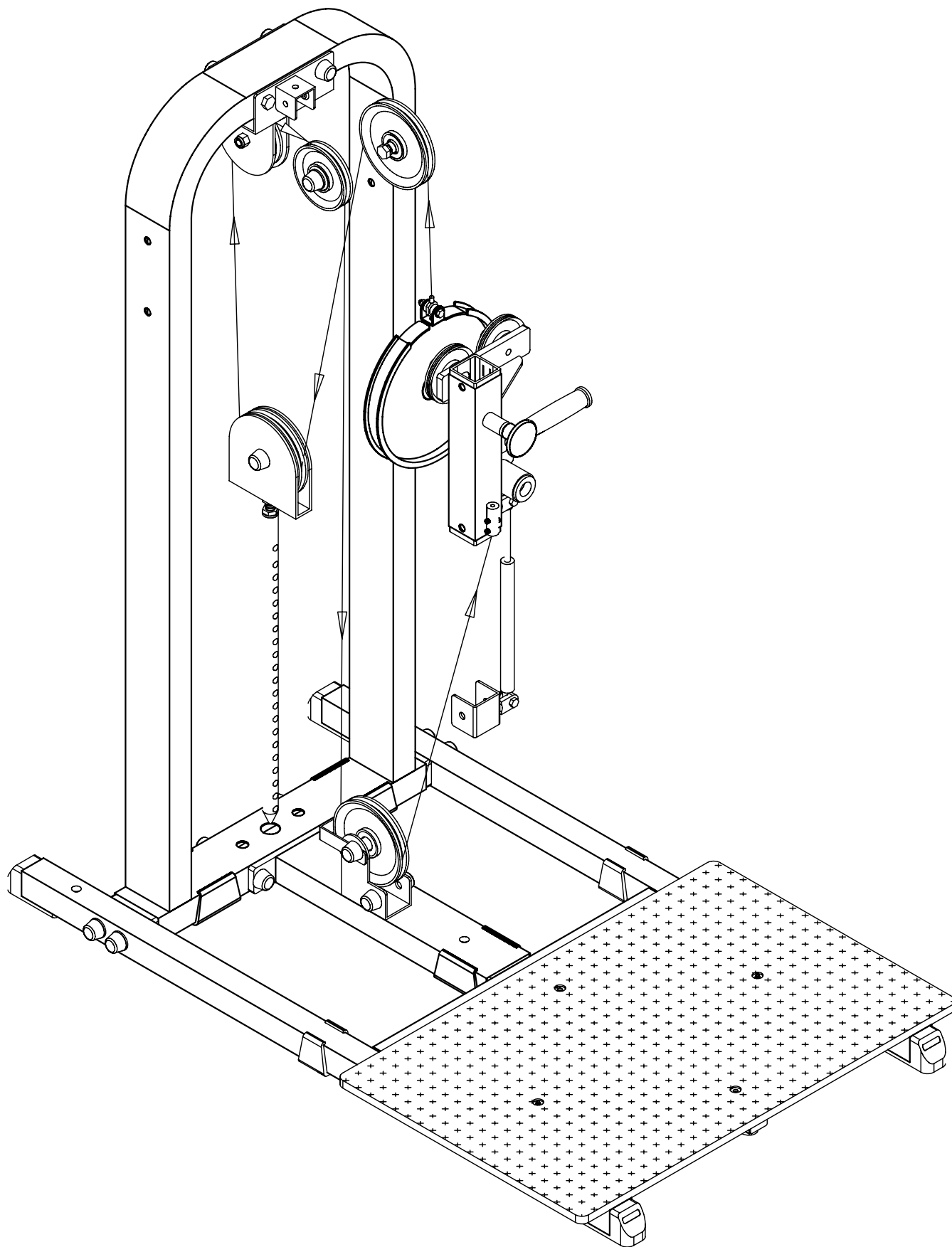

SMH-1500G.1

